

UltraDish™ TP 24

PARABOLIC DISH ANTENNA WITH TWISTPORT™ CONNECTOR

UltraDish™ TP 24 is designed for subscriber module applications. Minimized sidelobes, wide frequency bandwidth, and stable gain in both polarizations assure dependable performance. Antenna reflector is made of aluminium to ensure a low weight and uniform shape. Our proprietary TwistPort™ waveguide connector enables intuitive radio connection and replacement.

Massive mount with improved grip and a wide range of applicable pole diameters makes the deployment easy and versatile. Stainless hardware comes with black coating to prevent from seizing at the installation.



Gain H

Azimuth Pattern H

Elevation Pattern H

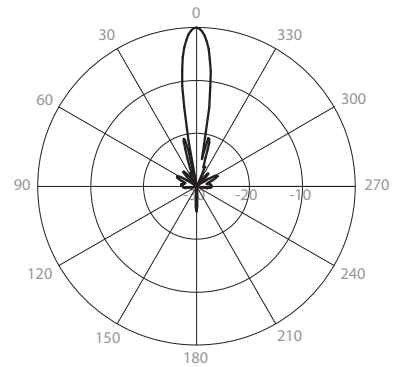
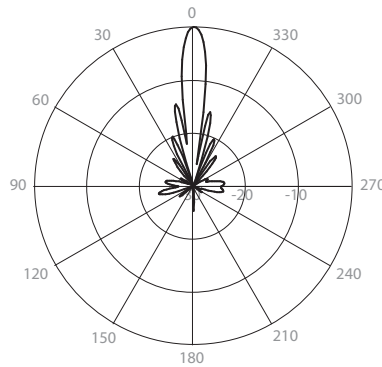
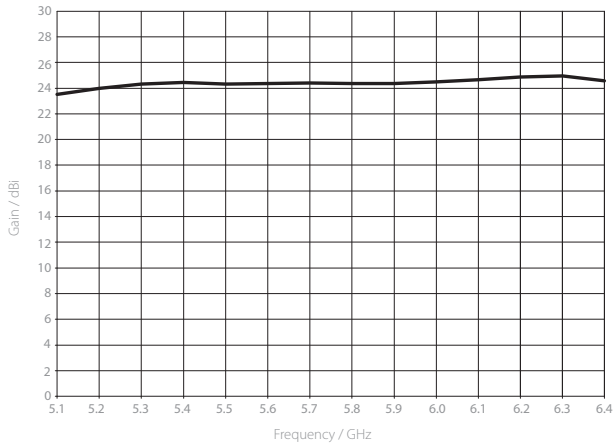

Gain V

Azimuth Pattern V

Elevation Pattern V

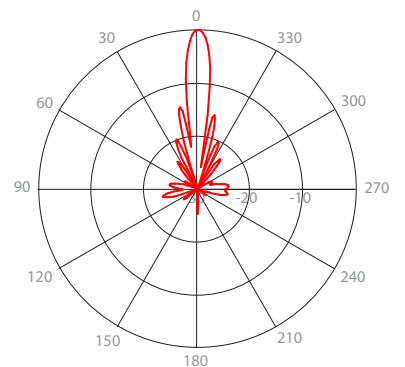
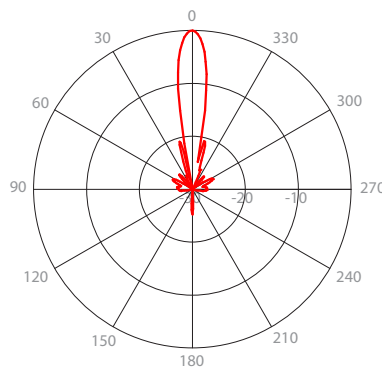
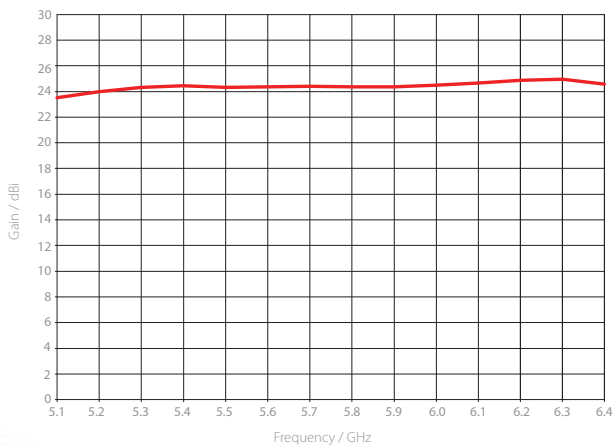

PHYSICAL

Antenna Connection	TwistPort™ - Quick Locking Waveguide Port
Antenna Type	Parabolic Dish
Materials	UV Resistant ABS Plastic, Polycarbonate, Aluminium, Stainless Steel
Environmental	IP65
Pole Mounting Diameter	40-80 mm (we recommend as close to 80mm as possible)
Temperature	-40 °C to +60 °C (-40°F to +140°F)
Wind Survival	160 km/hour
Wind Loading	167 N at 160 km/hour
Weight	2.7 Kg / 6 lbs – single unit (one antenna) 7.3 Kg / 16 lbs – 2PACK (2 units) incl. package
Dimensions	Retail Box 2PACK: 470 x 470 x 205 mm / 18.5 x 18.5 x 8.0 inch

PERFORMANCE

Gain	24.4 dBi
Frequency Range	5180 - 6400 MHz
Azimuth Beam Width -6 dB	H 12° / V 11°
Elevation Beam Width -6 dB	H 11° / V 12°
Azimuth Beam Width -3 dB	H 9° / V 8°
Elevation Beam Width -3 dB	H 8° / V 9°
Beam Efficiency**	40%
Front-to-Back Ratio (Min)	35 dB

COMPATIBLE WIRELESS PLATFORMS

any TwistPort™ Adaptor
any SIMPER™ Radio

PRODUCT DIMENSIONS

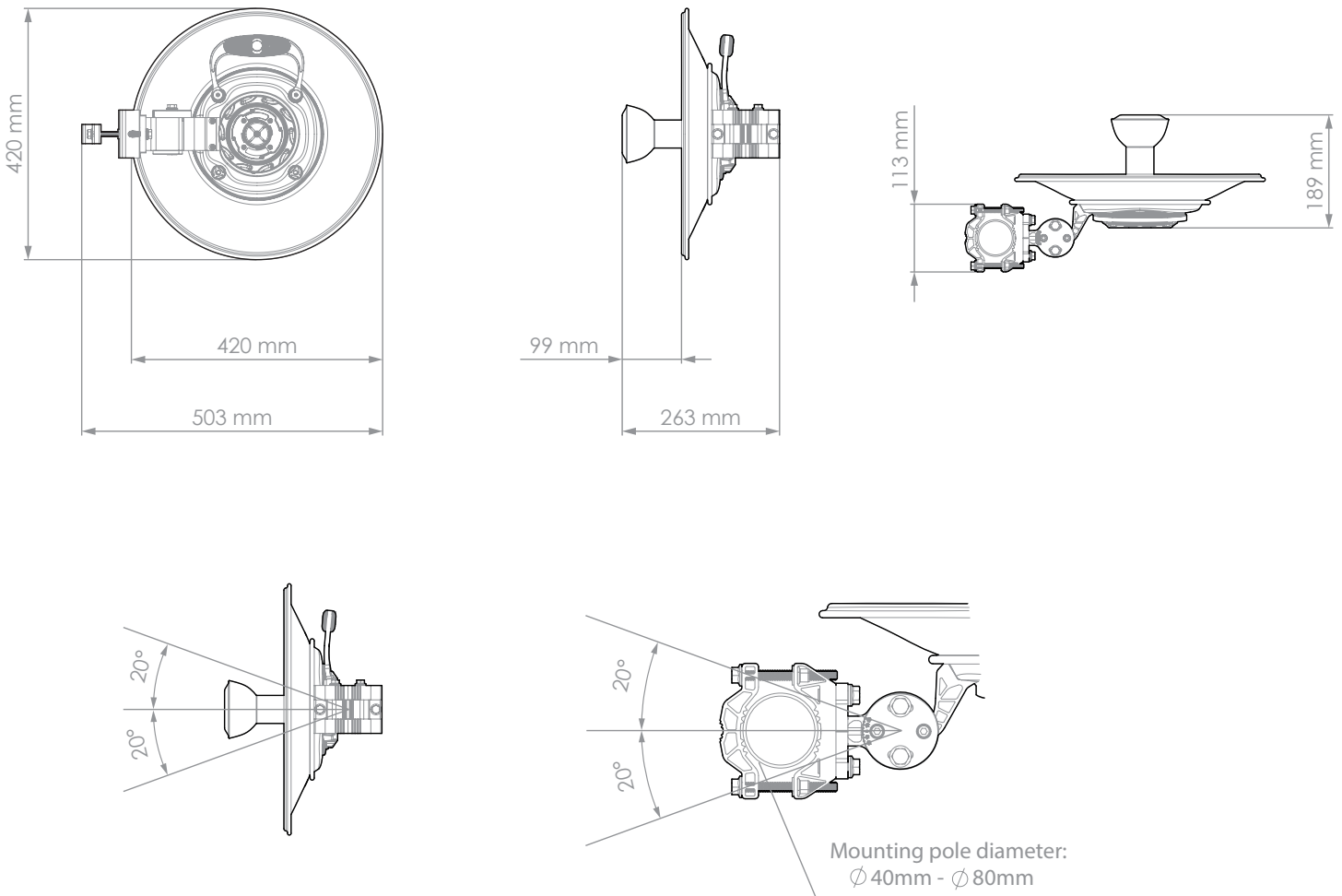

**Beam efficiency defined up to first null